

17 LR 20 Lp+R



153 –
179 kNm



8,5 –
10,2 m



3,87 –
4,04 m



5 m



2.770 –
2.920 kg



405°



30 kNm



265 –
300 bar



75 l/min
~ 61 kW



150 l/min
~ 71 kW

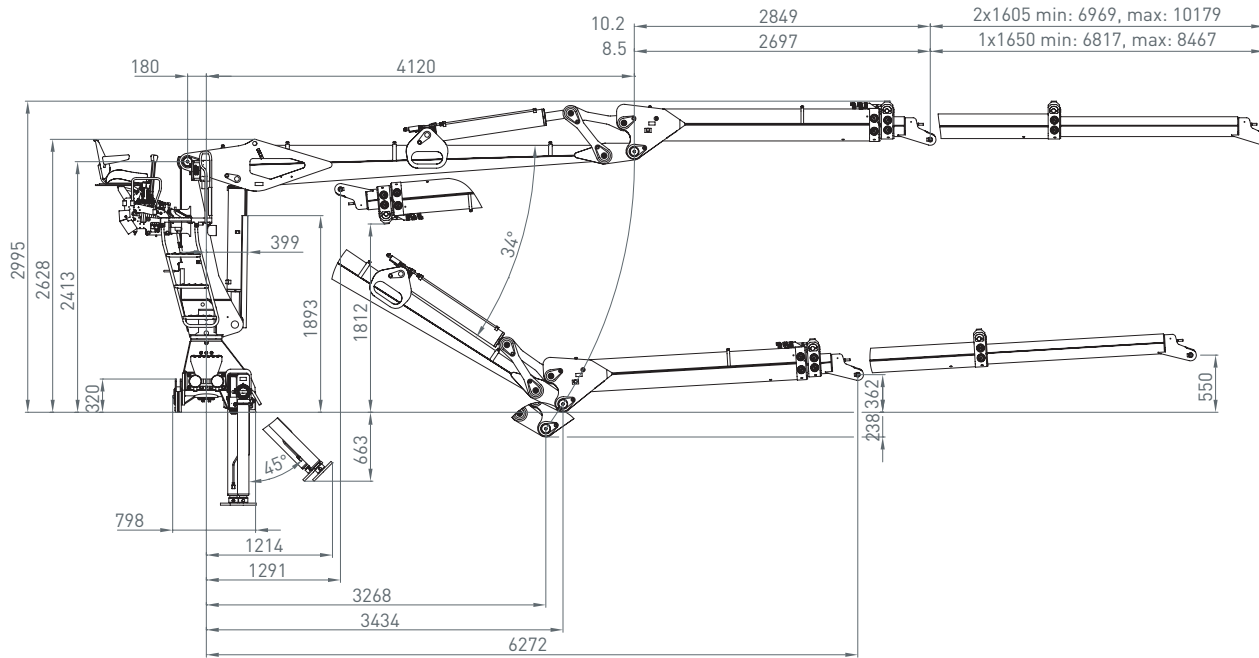

10,2

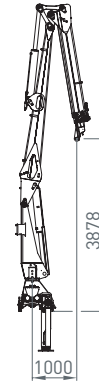

8,5

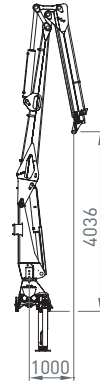

Sockel breit
Crane base wide

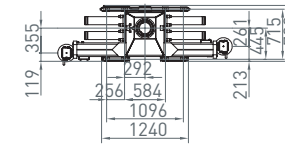
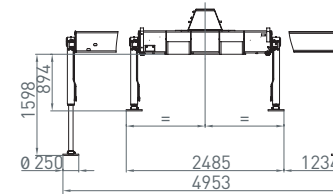

Vierkantabstützung
squared outridge

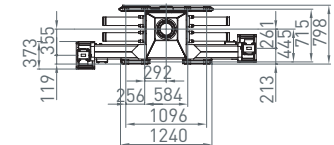
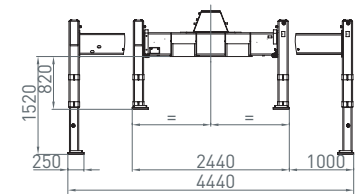

	4m	5m	6m	7m	8m	9m	10m	
17L10.20R	3880	3110	2590	2200	1900	1610	1440	kg
20Lp+10.20R	4385	3515	2925	2485	2145	1815	1625	kg
17L8.50R	4020	3210	2675	2290	1990	-	-	kg
20Lp+8.50R	4545	3625	3020	2585	2245	-	-	kg

Rücksitz 01
Back seat 01

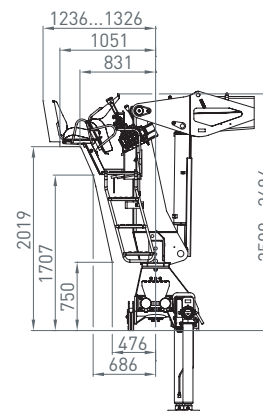

Rücksitz 02 universal
Back seat 02 universal

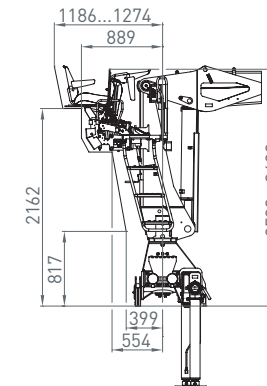

Seitensitz 02 universal rechts & links
Side seat 02 universal right & left

