

25 L 30 Lp+

228 - 284 kNm	8,3 - 10,1 m	3,4 - 3,6 m	3,5 - 5,1 m	2.620 - 2.810 kg	415°	38 kNm	235 - 285 bar	2x Minimum 90 l/min ~ 80 kW	LS Minimum 180 l/min ~ 80 kW

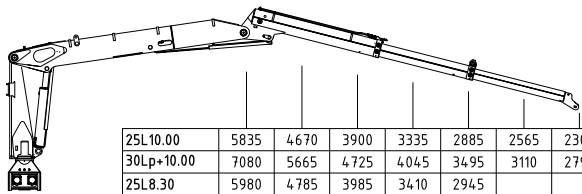

25L10.00	5835	4670	3900	3335	2885	2565	2305	[kg]
30Lp+10.00	7080	5665	4725	4045	3495	3110	2795	[kg]
25L8.30	5980	4785	3985	3410	2945			[kg]
30Lp+8.30	7255	5800	4830	4140	3575			[kg]

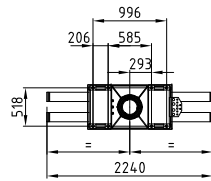
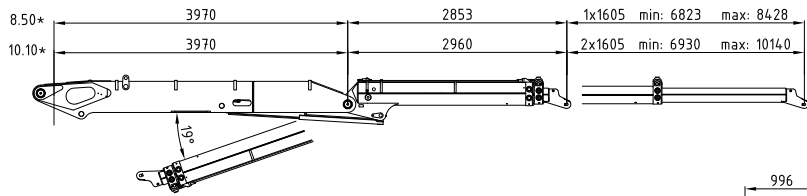
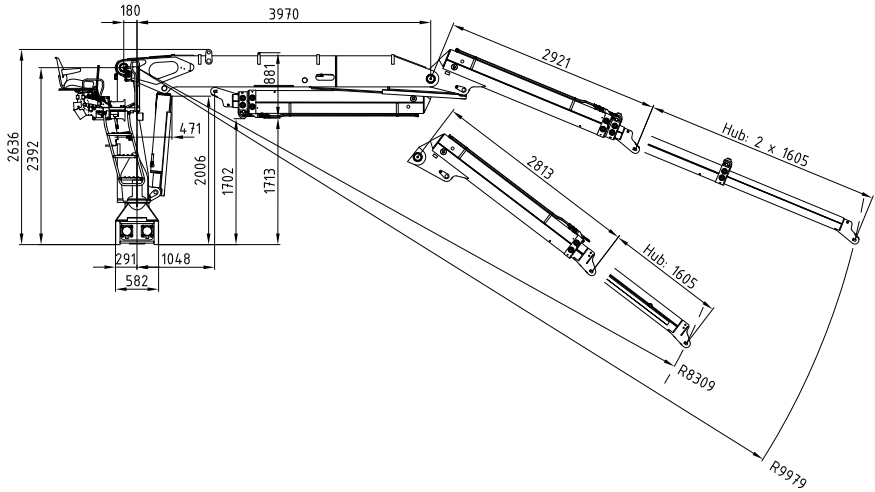
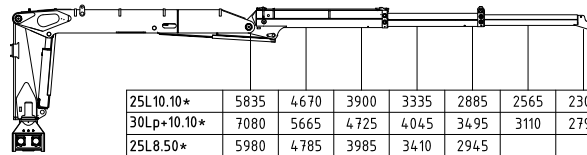

25L10.10*	5835	4670	3900	3335	2885	2565	2305	[kg]
30Lp+10.10*	7080	5665	4725	4045	3495	3110	2795	[kg]
25L8.50*	5980	4785	3985	3410	2945			[kg]
30Lp+8.50*	7255	5800	4830	4140	3575			[kg]

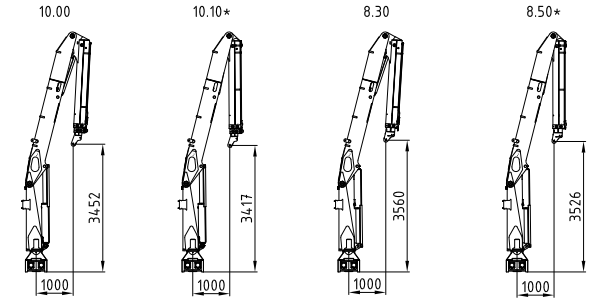

Schwenkabstützung / slewing outrigger

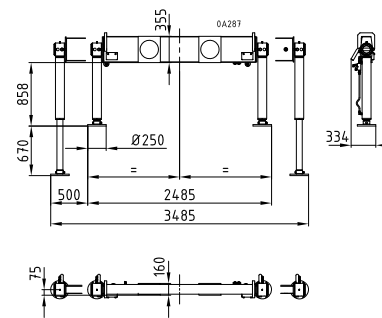

Vierkantabstützung / squared outrigger

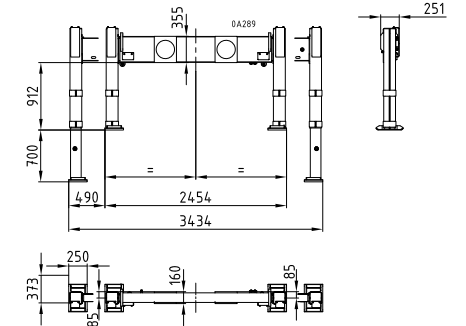

Schwenkabstützung breit / slewing outrigger wide

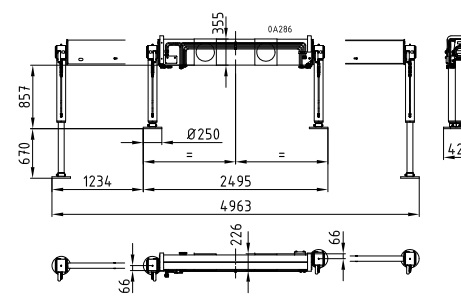

Vierkantabstützung breit / squared outrigger wide

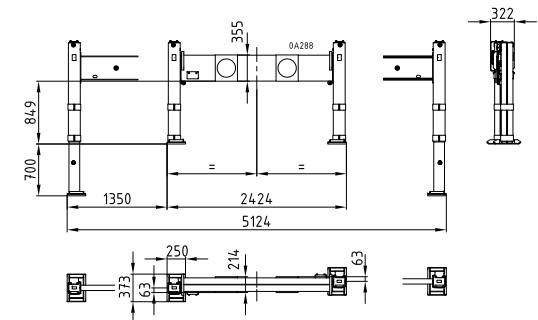

Rücksitz 01
Back seat 01

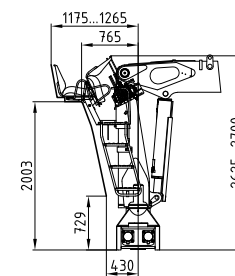

Rücksitz 04
Back seat 04

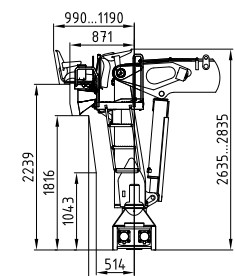

Seitensitz 04
side seat 04

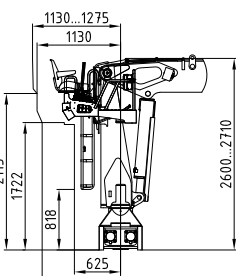

*gestreckt / stretched

Hublasten netto ohne Lastaufnahmemittel / lifting capacities without equipment

Rev05 erstellt am / established on 15.03.2017 von / by SoS

Technische Änderungen vorbehalten / technical changes reserved